

# NISSAN

**FITTING INSTRUCTIONS FOR  
T31 X TRAIL 08/07  
TOWBAR WIRING HARNESS  
PART NO. B4097-JG100AU  
FITTING TIME: APPROX 45 MIN**

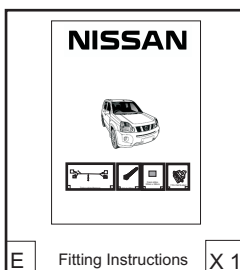
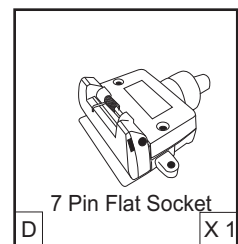
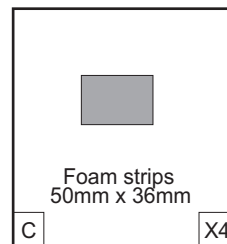
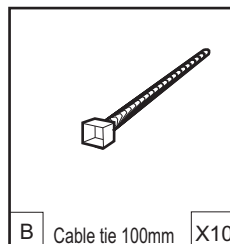
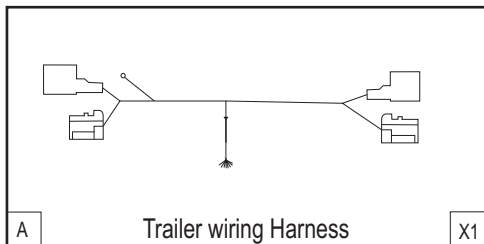

FIN10018  
04/11/09

# NISSAN

## FITTING INSTRUCTIONS FOR NISSAN T31 X TRAIL TOWBAR WIRING HARNESS

### Fitting Instructions:

1. Remove 2 piece luggage floor board assembly. Refer ( Fig 1A ).
2. Remove RHS luggage drawer and if fitted LHS luggage drawer. Refer(Fig 1B).
3. Remove LHS and RHS plastic press studs by depressing centre. Refer ( Fig 1C ).
4. Rotate both LHS and RHS locking tabs in far corners of luggage tray. Angle the luggage tray and carefully remove.
5. Remove spare wheel foam insert. Unscrew spare wheel retainer and remove spare wheel.
6. Remove weather seal from LHS and RHS and centre rear tailgate. Refer ( Fig 1D ) and ( Fig 16 ) on Page 8. Remove tailgate sill trim.
7. Remove accessory compartment lids from both RHS and LHS. Remove spare wheel jack and tools from LHS compartment.
8. Using a 10mm socket remove both LHS and RHS child seat restraint anchor from rear corner trim. Refer ( Fig 2 A ).
9. Lift rear hook assembly( Fig 3A ) and using 10mm socket remove screws. Repeat for opposite side.
10. Remove cargo blind cavity trim cover and using 10mm socket remove bolt for LHS and RHS. Refer ( Fig 3C ).
11. Remove overhead luggage net hook from roof liner. Repeat for opposite side.

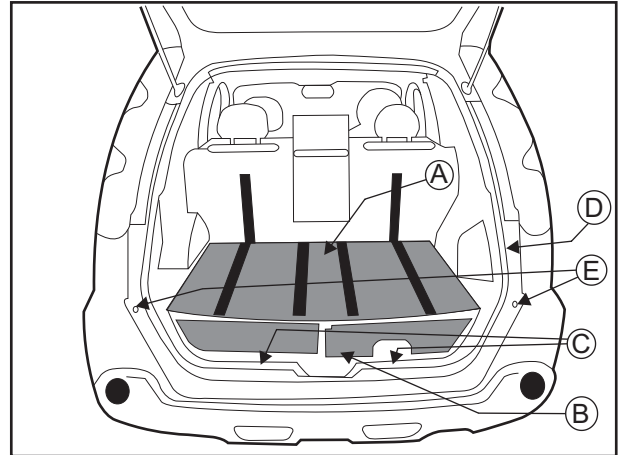

FIGURE 1

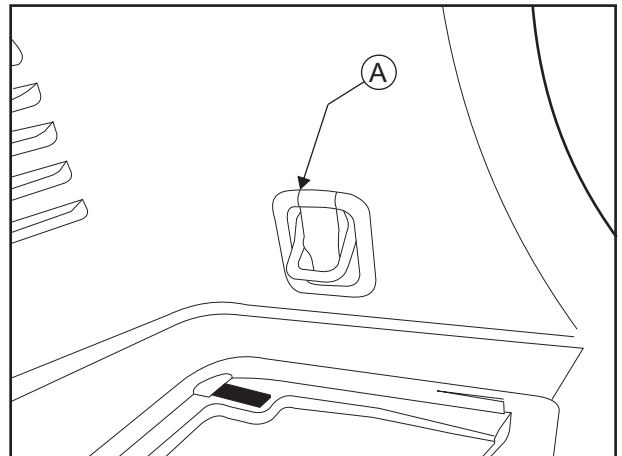

FIGURE 2

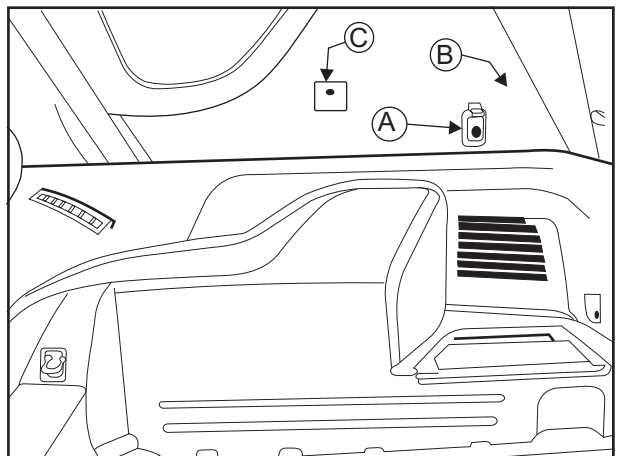

Figure 3

FIN10018

04/11/09

# NISSAN

## FITTING INSTRUCTIONS FOR NISSAN T31 X TRAIL TOWBAR WIRING HARNESS

FITTING INSTRUCTIONS: Continued..

12. Carefully pull back lower rear quarter panel trim. Carefully pull back upper rear quarter panel trim. Refer ( Fig 3B ).
13. Disconnect rear right indicator connector. Refer ( Fig 4A ). Connect towbar harness to vehicle harness and to indicator holder. Refer ( Fig 5A ).
14. Secure harness to vehicle body using adhesive foam supplied. Ensure surface is clean and free of dirt. Refer ( Fig 5B ).
15. If RPA is fitted, remove yellow PVC tape on towbar harness and connect the RPA inhibit connector to the module. Refer ( Fig 6A ).
16. Secure running length of harness to vehicle body in corner using adhesive foam supplied. Ensure surface is clean and free from dirt. Refer ( Fig 7A ).
17. Ensuring harness is in cavity, replace upper rear quarter panel trim. Replace lower quarter panel trim.
18. Secure harness to vehicle body at either side of tailgate striker using adhesive foam patches. Ensure near the tailgate striker, the harness is on the topside of the sheet metal. Refer ( Fig 8A ).

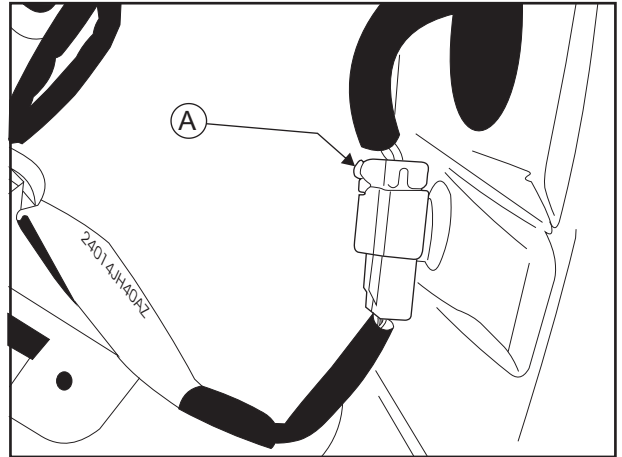

FIGURE 4

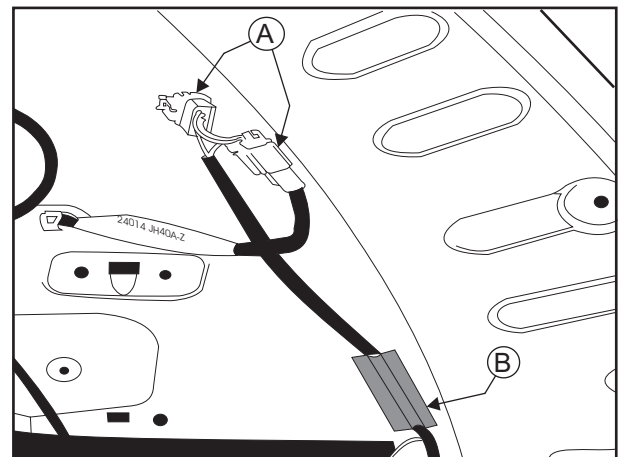

FIGURE 5

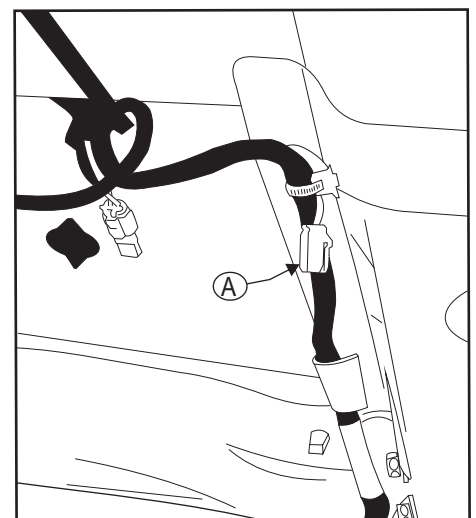

FIGURE 6

# NISSAN

## FITTING INSTRUCTIONS FOR NISSAN T31 X TRAIL TOWBAR WIRING HARNESS

FITTING INSTRUCTIONS: Continued..

19. Carefully pull back the upper quarter panel trim. Release the locking of the trim from the top side of the left rear quarter panel window section.
20. Using a 10mm socket remove the ground terminal screw from behind the upper quarter panel trim on the sheet metal. Refer ( Fig 9A ).
21. Disconnect the rear left indicator connector. Connect towbar patch harness to vehicle harness and to indicator holder. Refer ( Fig 9B ).
22. Route the white ground lead behind the vehicle harness. Using the ground screw, secure the towbar harness ground lead and the other ground terminals to the sheet metal. Refer ( Fig 9A ).
23. Using the cable ties provided secure the towbar harness to the vehicle harness in three points.
24. Remove grommet from rear left cavity. Feed main towbar harness through hole. Grommet on towbar harness will be engaged by pulling on the other end of harness. Refer ( Fig 10A & Fig 11A ).

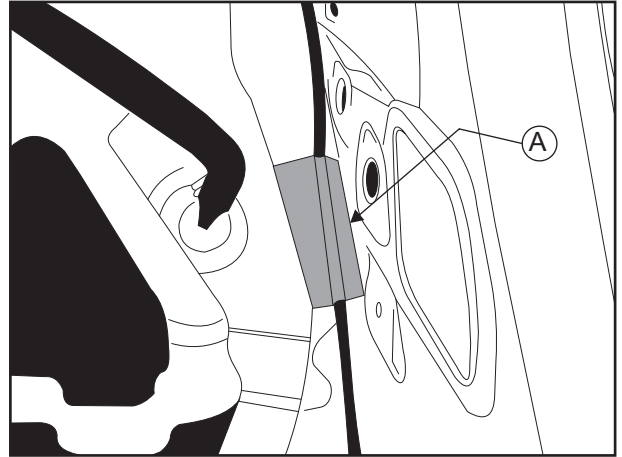

FIGURE 7

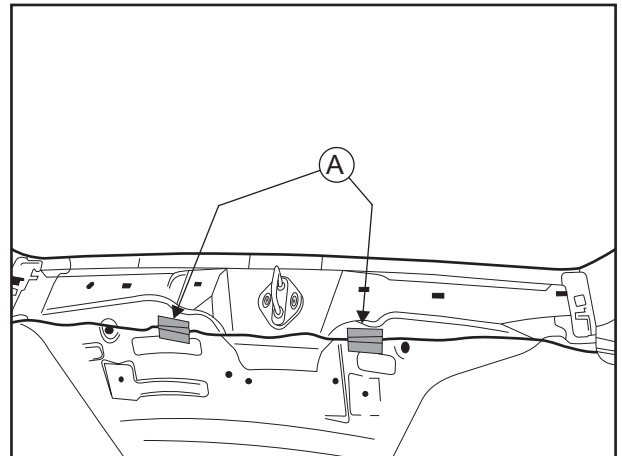

FIGURE 8

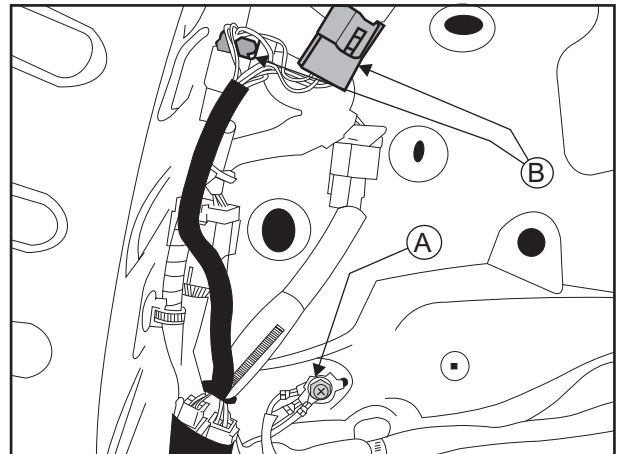

FIGURE 9

# NISSAN

## FITTING INSTRUCTIONS FOR NISSAN T31 X TRAIL TOWBAR WIRING HARNESS

FITTING INSTRUCTIONS: Continued..

25. Raise vehicle to a safe working height. Using a T20 Torx remove rear left and rear right mud flaps.
26. Remove splash guards from rear left and right wheel wells by removing plastic screws. Refer ( Fig 12A ). Partially remove rear wheel arch mouldings.
27. Using a Philips screw driver remove two 10mm screws from rear bumper fascia brackets. Repeat for other side. Refer ( Fig 1E ).
28. Remove the two plastic screws from the outside of the centre of the bumper fascia. Remove the 10mm screws from both the upper sides of the bumper fascia. Refer ( Fig 13A ).
29. Unclip the bumper fascia. Ensure to disconnect both reversing lamp connectors. If RPA is connected disconnect both RPA sensors.
30. Using 5 cable ties provided secure towbar harness to vehicle harness. Ensure harness is routed clear of exhaust. Refer ( Fig 14A ).
31. Wire up towbar harness to the towbar connector. Refer table. Secure the towbar connector to the towbar plate. Refer ( Fig 15 ).
32. Carefully replace rear bumper fascia ensuring to reconnect the reversing lamp connectors.

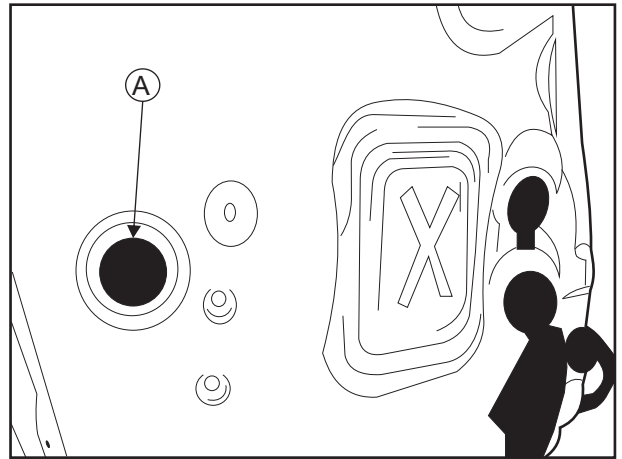

FIGURE 10

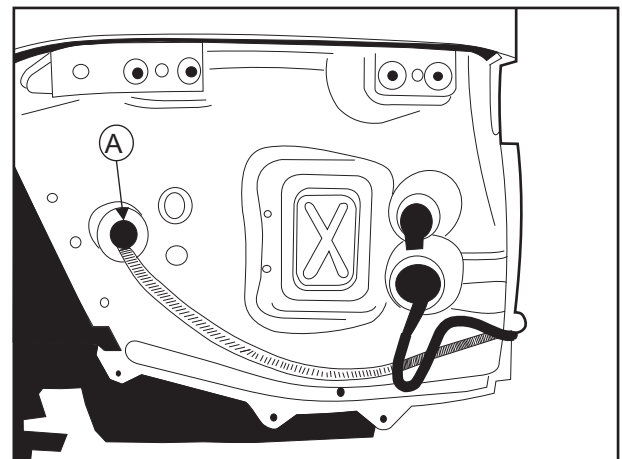

FIGURE 11

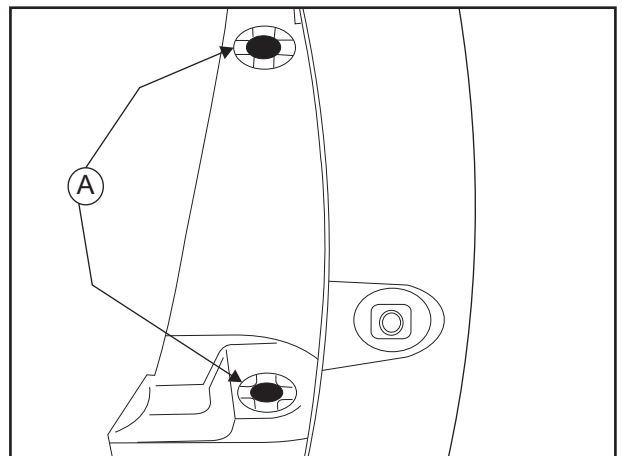

FIGURE 12

FIN10018

04/11/09

# NISSAN

## FITTING INSTRUCTIONS FOR NISSAN T31 X TRAIL TOWBAR WIRING HARNESS

FITTING INSTRUCTIONS: Continued..

33. Replace the two 10mm screws to the top section of the rear left and right of the bumper fascia. Refer ( Fig 1E ). Replace the two plastic screws to the centre of the underside of the rear bumper fascia.
34. Replace the two 10mm screws for the rear bumper fascia bracket inside the wheel arch. Repeat for other side. Refer ( Fig 13A ).
35. Replace rear wheel arch moulding. Using the two plastic rivets secure the splash guard. Repeat for other side.
36. Using the three T20 Torx replace the rear left and right mudflaps. Replace the screw to the back underside of the mudflap. Lower vehicle to ground level.
37. Replace upper and lower rear quarter panel trim. Replace plastic hooks. Secure child seat restraint anchors.
38. Replace in the following order, floor level trim, rubber rear tailgate weather seal, spare wheel and secure using spare wheel retainer, spare wheel foam insert, cargo tray ( securing at all four corners ), right hand side luggage drawer and two piece luggage floor.

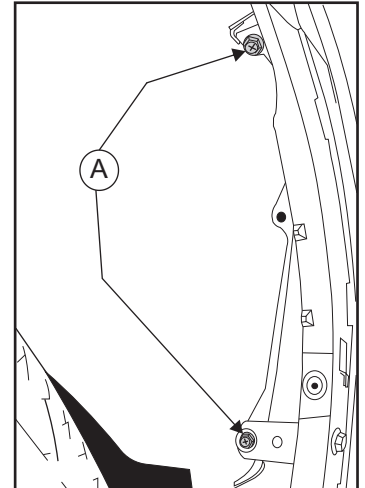

FIGURE 13

# NISSAN

## FITTING INSTRUCTIONS FOR NISSAN T31 X TRAIL TOWBAR WIRING HARNESS

FITTING INSTRUCTIONS: Continued..

39. Test the operation of the trailer socket using a trailer wiring tester or a test light to ensure correct operation.

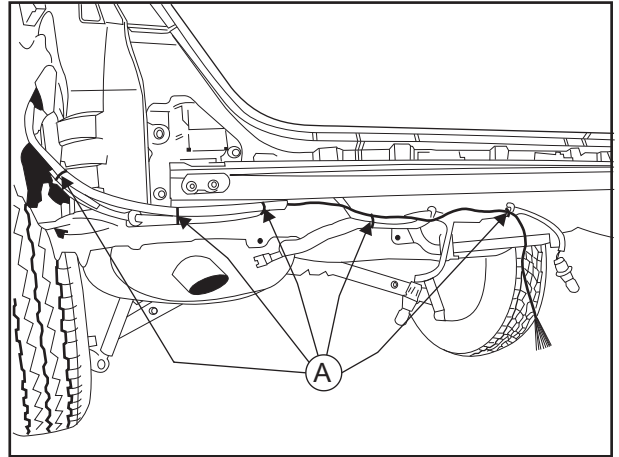

FIGURE 14

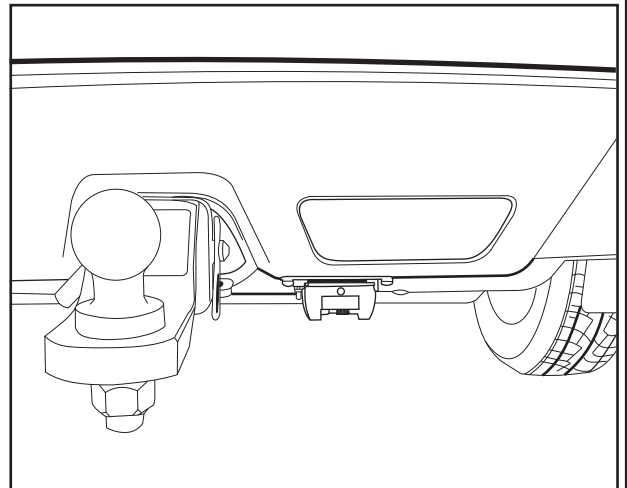
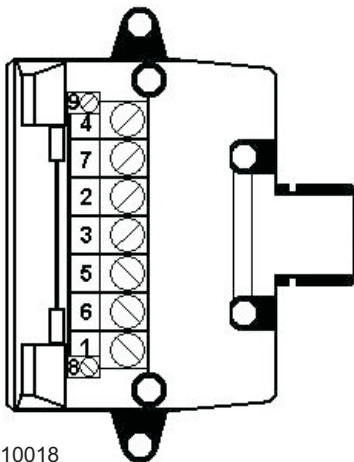

FIGURE 15



| NO. | FUNCTION            | WIRE COLOUR |
|-----|---------------------|-------------|
| 1   | L/H INDICATOR       | YELLOW      |
| 3   | EARTH               | WHITE       |
| 4   | R/H INDICATOR       | GREEN       |
| 6   | STOP LIGHT          | RED         |
| 7   | TAIL LIGHT          | BROWN       |
| 8   | REVERSE PARK SENSOR | BLUE/BLACK  |
| 9   | REVERSE PARK SENSOR | GREY        |

FIN10018  
04/11/09

# NISSAN

## FITTING INSTRUCTIONS FOR NISSAN T31 X TRAIL TOWBAR WIRING HARNESS

FITTING INSTRUCTIONS: Continued..

40. The correct method to remove the weather strip is to peel back the luggage compartment side trim, grip the weather strip/welt at the base and pull back to remove.

Refer ( Fig 16 )

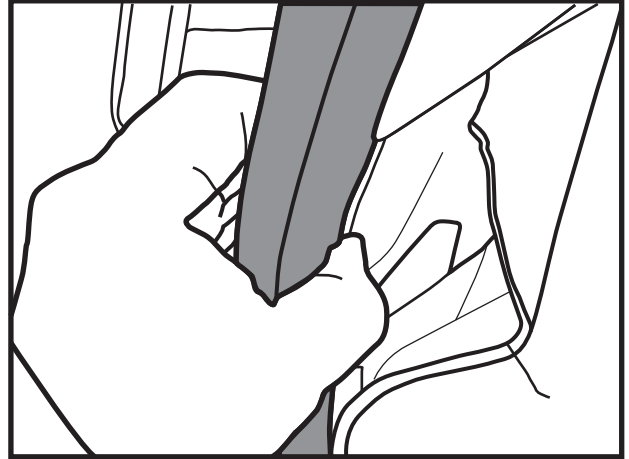

FIGURE 16